

# SELECTIONALS<sup>®</sup>

by STICKLEY.



CUSTOM UPHOLSTERY & LEATHER

# CUSTOM.

Selectionals®, the most flexible, most comprehensive custom upholstery program available, executed to the highest standards of Stickley® comfort and craftsmanship.

Whether you enjoy the elegance of finely tailored traditional sofas, the low sleek lines of a contemporary sectional, or the casual comfort of finely executed motion furniture, the Selectionals Custom Upholstery Program offers you a world of design opportunities. From a great room to a cozy corner, the broad array of sofa, loveseat, chair, sleep sofa or sectional components, along with dozens of arm, back and base options, lets you scale and design the piece that's just right for you.

Whatever the style, scale or function, you can be assured that comfort and craftsmanship has been engineered into every piece from the Stickley Selectionals program.



Above: 200 Series sofa 96-9696-1D-2B-3F shown in fabric 7286-95

Right: 500 Series sofa 96-9845-1E-2G-3T shown here in fabric 7528-35

Cover:  
96-7012-40-1G-2B-3B Left Facing 7000 Loveseat,  
96-7019-40-1G-2B-3B Right Facing 7000 Chaise,  
CL-7003-38-1G-2B-3B 7000 Chair

## CHOOSE YOUR SERIES

Creating your own Selectional is easy! **Six great programs** provide custom upholstery for every taste, every lifestyle and every function! Begin by choosing which of the six series is right for you.



The **7000 Series** brings three depths for exceptional comfort and choice, with the ability to pick a scale that matches any environment.

seat height	21"	overall height	35½-37¼"
seat depth	21-25"		
frame depth	36-40"		

**7000 Series** see page 6

The **300 Series** is low, sophisticated and contemporary. Clean, modern style elements include armless and waterfall skirt options.

seat height	20"	overall height	31-33"
seat depth	24"		
frame depth	38"		



**300 Series** see page 30

The **100 Series** offers universal comfort for universal appeal, with the largest selection of options, plus custom sleepers and by-the-inch sofas.



**100 Series** see page 12

seat height	22½"	overall height	36¼-38½"
seat depth	21"	Sofas by the Inch	
frame depth	36"	sleep sofas	



**400 Series** see page 38

The **400 Series** offers custom motion upholstery that doesn't look like motion and provides incliner seating wherever you want it.

seat height	20½"	overall height	40½-42¼"
seat depth	21"	motion units	
frame depth	41"		



The **200 Series** has deeper frames and more opulent seating. These larger designs for larger rooms include additional standard throw pillows.

seat height	21½"	overall height	36½-39¾"
seat depth	24"		
frame depth	40"		

**200 Series** see page 22

The **500 Series** offers lighter scale, lower seating, clean, finely scaled arm styles, with waterfall skirt and tall leg options.

seat height	20"	overall height	36½-36¾"
seat depth	20½"	Sofas by the Inch	
frame depth	37"		



**500 Series** see page 46

# 7000 SERIES



7000 Series sofa 96-7000-40-1C-2B-3J, shown in fabric 1248-39 TPS 5354-35,  
96-7003-38-1C-2B-3A chair, shown in fabric 9347-35

# 7000 SERIES

Large or small, traditional to modern, create custom upholstery that's scaled to perfection by choosing from three frame depths.

seat height	21"
seat depth	21-25"
frame depth	36-40"
overall height	35½-37¼"
seat cushions	spring down
back pillows	fiber down
throw pillows	varies
skirts	9" kick pleat



## HOW TO CREATE YOUR MODEL NUMBER

Creating your 7000 Series Selectional in five easy steps! Start by picking the sofa, chair, sleep sofa or sectional configuration that best fits your room and your lifestyle from the 7000 Series components shown on pages 10 and 11.



96-7000  
Three Cushion Sofa

For example, you've selected the **96-7000 Three Cushion Sofa**. Now, just follow these **five** simple steps:

- 1 SELECT YOUR FRAME**  
We are starting with the **96-7000 Three Cushion Sofa**
- 2 SELECT YOUR DEPTH**  
96-7000-**36**  
Choose from 3 new depths  
36"(seat depth 21")  
38"(seat depth 23")  
40"(seat depth 25")
- 3 SELECT YOUR ARM STYLE**  
**1G**  
Weltless Club Arm
- 4 SELECT YOUR BACK STYLE**  
**2B**  
Box Back
- 5 SELECT YOUR BASE STYLE**  
**3F**  
Short Block Leg

You've selected the **36** for your depth, **1G** arm style with the **2B** back style and the **3F** base style. So the model number on your order should be **96-7000-36-1G-2B-3F**

Finally, select your fabric or leather, select your finish and add the frills (upholstery only).

Any Stickley fabric is available at no charge for contrast throw pillows. Any Grade 1 Stickley trim is available at no charge on throw pillows. Pure down/feather back cushions are available at no charge. Throw pillows are not standard on leather upholstery. All legs are maple. Multiple piece sectionals will be center-matched.

## ARM STYLES – WELTED UNLESS OTHERWISE NOTED

## 7000 SERIES

<b>1A</b> Pleated Arm H26 W10	<b>1B</b> Classic Roll Arm H26½ W8½	<b>1F</b> Traditional Roll Arm H25½ W10	<b>1G</b> Weltless Club Arm H25½ W6 (Seats, Backs, Throw Pillows Weltless)	<b>1D</b> Track Arm H25½ W6	<b>1C</b> English Arm H26½ W6½
<b>1E</b> Sock Arm H26 W9	<b>1L</b> Classic Roll Arm w/Nailhead Trim H26½ W8½	<b>1M</b> Traditional Roll Arm w/ Nailhead Trim H25½ W10	<b>1W</b> Club Arm H25½ W6	<b>1P</b> Flared Sock Arm H27 W10	

## BACK STYLES

<b>2A</b> Knife Edge Back Overall H36	<b>2B</b> Box Back Overall H36	<b>2H</b> Casual Tightback Overall H36½	<b>2K</b> Tall Knife Edge Back Overall H37¼	<b>2L</b> Tall Box Back Overall H37¼

### Back Option Notes:

•2H not available on corner loveseats or corner sofas

### Base option Notes:

•3A not available in leather or storage ottomans

•3C, 3D, 3E, 3J not available on storage ottomans

## BASE STYLES

<b>3A</b> Kick Pleat Skirt H9	<b>3B</b> Floating Base H1	<b>3C</b> Block Leg H4	<b>3D</b> Tapered Leg H4	<b>3E</b> Bun Foot H4	<b>3F</b> Short Block Leg H2½	<b>3G</b> Short Bun Foot H2½	<b>3J</b> Recessed Tapered Leg H4

## SOFAS, LOVESEATS AND CHAIRS

## 7000 SERIES

THROW PILLOW CONFIGURATIONS – THROW PILLOWS VARY BY DEPTH AND STYLE SELECTION

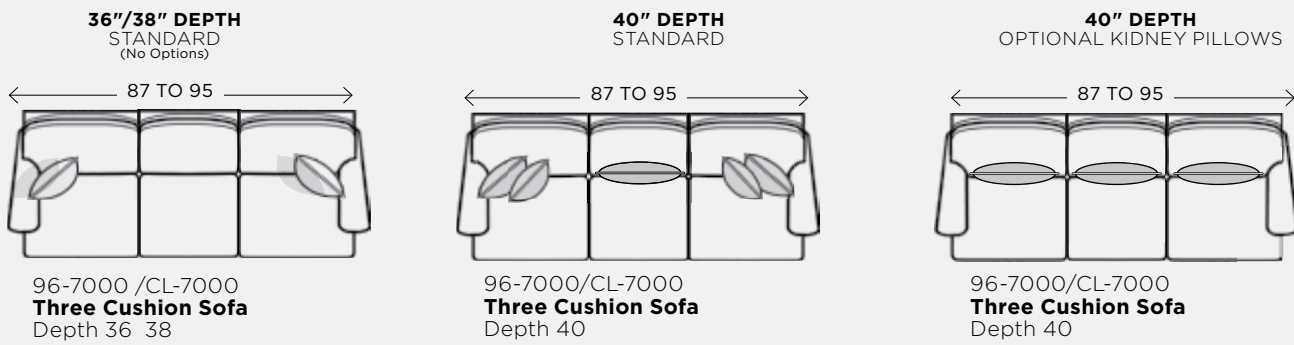

## SECTIONAL COMPONENTS

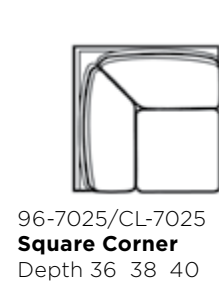
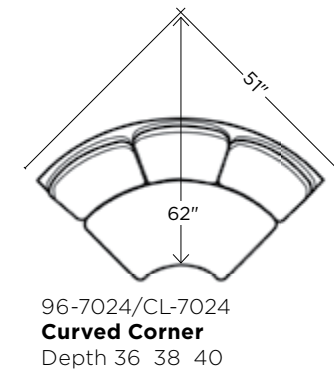
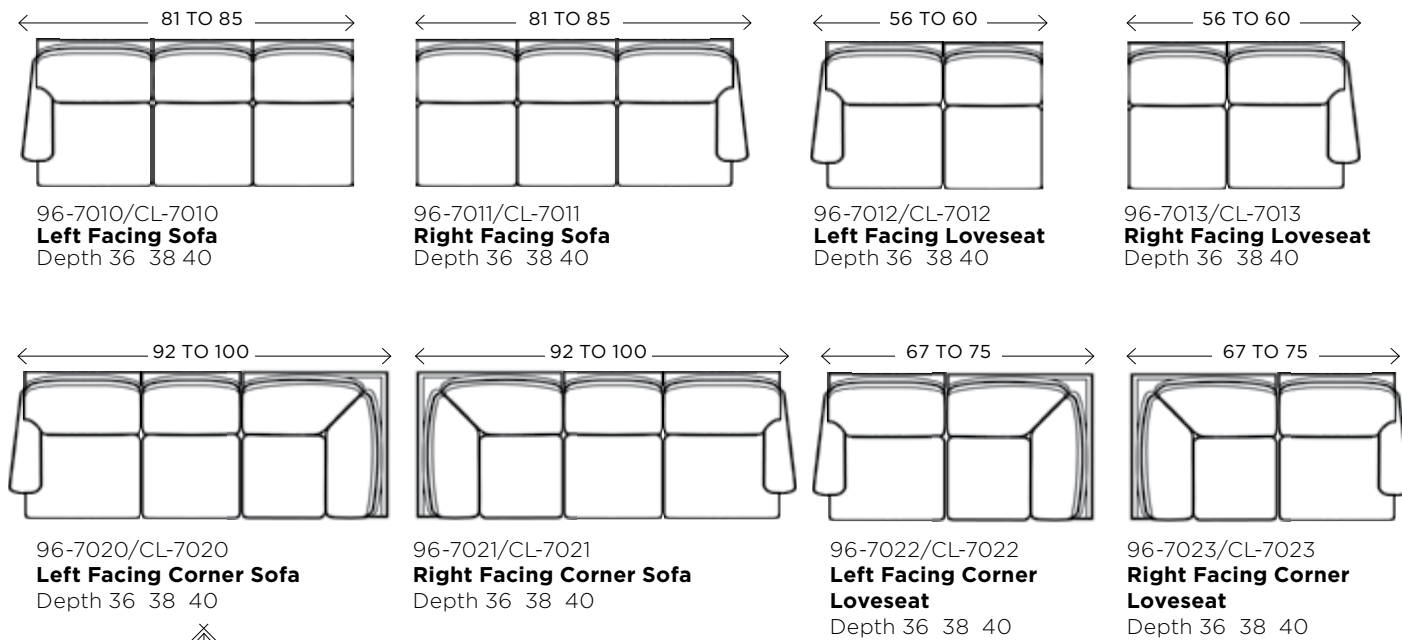

## OTTOMANS

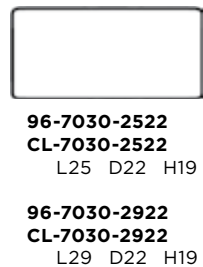

**96-7030-3625**  
**CL-7030-3625**  
L36 D25 H19

Also available as storage ottoman  
**96-7030-3625-ST**  
**CL-7030-3625-ST**  
L36 D25 H19

**96-7030-4825**  
**CL-7030-4825**  
L48 D25 H19

Also available as storage ottoman  
**96-7030-4825-ST**  
**CL-7030-4825-ST**  
L48 D25 H19

**96-7030-6025**  
**CL-7030-6025**  
L60 D25 H19

Also available as storage ottoman  
**96-7030-6025-ST**  
**CL-7030-6025-ST**  
L60 D25 H19



## SECTIONAL COMPONENTS

## 7000 SERIES

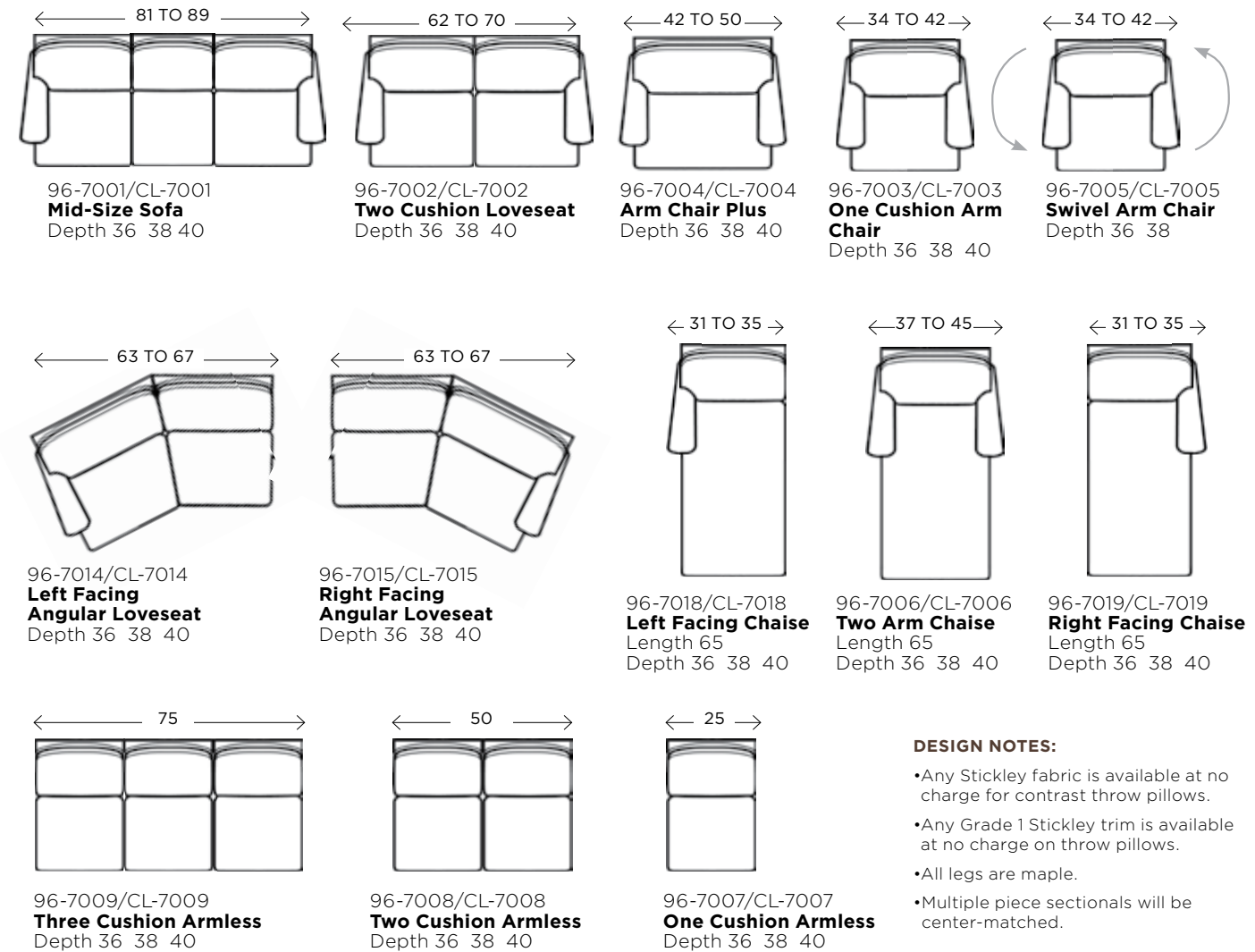

- DESIGN NOTES:**
- Any Stickley fabric is available at no charge for contrast throw pillows.
  - Any Grade 1 Stickley trim is available at no charge on throw pillows.
  - All legs are maple.
  - Multiple piece sectionals will be center-matched.

## THROW PILLOW OPTIONS – SQUARE & KIDNEY

Item No.	Item Name	36" / 38" Depth Standard	40" Depth Standard	40" Depth Optional Kidney
96-7000	Three Cushion Sofa	2-20" Square	4-20" Square & 1-Kidney	3-Kidney
96-7001	Mid Size Sofa	2-20" Square	4-20" Square & 1-Kidney	3-Kidney
96-7002	Two Cushion Loveseat	2-20" Square	4-20" Square	2-Kidney
96-7003	Arm Chair	N/A	1-Kidney	NA
96-7004	Arm Chair Plus	N/A	1-Kidney	NA
96-7005	Swivel Chair	N/A	No 40" Swivel Chair	
96-7006	Two Arm Chaise	N/A	1-Kidney	NA
96-7007	One Cushion Armless	N/A	1-Kidney	NA
96-7008	Two Cushion Armless	N/A	2-Kidney	NA
96-7009	Three Cushion Armless	N/A	3-Kidney	NA
96-7010	LF Sofa	1-20" Square	2-20" Square	3-Kidney
96-7011	RF Sofa	1-20" Square	2-20" Square	3-Kidney
96-7012	LF Loveseat	1-20" Square	2-20" Square	2-Kidney
96-7013	RF Loveseat	1-20" Square	2-20" Square	2-Kidney
96-7014	LF Angular Loveseat	1-20" Square	2-20" Square	2-Kidney
96-7015	RF Angular Loveseat	1-20" Square	2-20" Square	2-Kidney
96-7016	Left Arm Chair	1-20" Square	2-20" Square	1-Kidney
96-7017	Right Arm Chair	1-20" Square	2-20" Square	1-Kidney
96-7018	LF Chaise	1-20" Square	2-20" Square	1-Kidney
96-7019	RF Chaise	1-20" Square	2-20" Square	1-Kidney
96-7020	LF Corner Sofa	2-20" Square	4-20" Square	4-Kidney
96-7021	RF Corner Sofa	2-20" Square	4-20" Square	4-Kidney
96-7022	LF Corner Loveseat	2-20" Square	4-20" Square	3-Kidney
96-7023	RF Corner Loveseat	2-20" Square	4-20" Square	3-Kidney
96-7024	Curved Corner	1-20" Square	2-20" Square	3-Kidney
96-7025	Square Corner	1-20" Square	2-20" Square	2-Kidney

**NOTE: Throw / Kidney Pillows are not standard on leather upholstery.**

**OUTSIDE LENGTHS BASED ON ARM STYLE**

**7000 SERIES**

Component #	Description	1A	1B	1C	1D	1E	1F	1G	1L	1M	1P	1W
96-7000 / CL-7000	Three Cushion Sofa	95"	92	88	87	93	95	87	92	95	95	87
96-7001 / CL-7001	Mid Size Sofa	89	86	82	81	87	89	81	86	89	89	81
96-7002 / CL-7002	Loveseat	70	67	63	62	68	70	62	67	70	70	62
96-7003 / CL-7003	Arm Chair	42	39	35	34	40	42	34	39	42	42	34
96-7004 / CL-7004	Arm Chair Plus	50	47	43	42	48	50	42	47	50	50	42
96-7005 / CL-7005	Swivel Arm Chair	42	39	35	34	40	42	34	39	42	42	34
96-7006 / CL-7006	Two Arm Chaise	45	42	38	37	43	45	37	42	45	45	37
96-7010 / CL-7010	LF Sofa	85	83½	81½	81	84	85	81	83½	85	85	81
96-7011 / CL-7011	RF Sofa	85	83½	81½	81	84	85	81	83½	85	85	81
96-7012 / CL-7012	LF Loveseat	60	58½	56½	56	59	60	56	58½	60	60	56
96-7013 / CL-7013	RF Loveseat	60	58½	56½	56	59	60	56	58½	60	60	56
96-7014 / CL-7014	LF Angular Loveseat	67	65½	63½	63	66	67	63	65½	67	67	63
96-7015 / CL-7015	RF Angular Loveseat	67	65½	63½	63	66	67	63	65½	67	67	63
96-7016 / CL-7016	LF Arm Chair	35	33½	31½	31	34	35	31	33½	35	35	31
96-7017 / CL-7017	RF Arm Chair	35	33½	31½	31	34	35	31	33½	35	35	31
96-7018 / CL-7018	LF Chaise	35	33½	31½	31	34	35	31	33½	35	35	31
96-7019 / CL-7019	RF Chaise	35	33½	31½	31	34	35	31	33½	35	35	31
96-7020 / CL-7020	LF Corner Sofa	Outside Length varies based upon Depth selection. See next page.										
96-7021 / CL-7021	RF Corner Sofa	Outside Length varies based upon Depth selection. See next page.										
96-7022 / CL-7022	LF Corner Loveseat	Outside Length varies based upon Depth selection. See next page.										
96-7023 / CL-7023	RF Corner Loveseat	Outside Length varies based upon Depth selection. See next page.										

**OUTSIDE LENGTHS BASED ON ARM STYLE**

**7000 SERIES**

**36" DEPTH - OUTSIDE LENGTHS BY ARM STYLE**

Component #	Description	1A	1B	1C	1D	1E	1F	1G	1L	1M	1P	1W
96-7020 / CL-7020	LF Corner Sofa	96	94½	92½	92	95	96	92	94½	96	96	92
96-7021 / CL-7021	RF Corner Sofa	96	94½	92½	92	95	96	92	94½	96	96	92
96-7022 / CL-7022	LF Corner Loveseat	71	69½	67½	67	70	71	67	69½	71	71	67
96-7023 / CL-7023	RF Corner Loveseat	71	69½	67½	67	70	71	67	69½	71	71	67

**38" DEPTH - OUTSIDE LENGTHS BY ARM STYLE**

Component #	Description	1A	1B	1C	1D	1E	1F	1G	1L	1M	1P	1W
96-7020 / CL-7020	LF Corner Sofa	98	96½	94½	94	97	98	94	96½	98	98	94
96-7021 / CL-7021	RF Corner Sofa	98	96½	94½	94	97	98	94	96½	98	98	94
96-7022 / CL-7022	LF Corner Loveseat	73	71½	69½	69	72	73	69	71½	73	73	69
96-7023 / CL-7023	RF Corner Loveseat	73	71½	69½	69	72	73	69	71½	73	73	69

**40" DEPTH - OUTSIDE LENGTHS BY ARM STYLE**

Component #	Description	1A	1B	1C	1D	1E	1F	1G	1L	1M	1P	1W
96-7020 / CL-7020	LF Corner Sofa	100	98½	96½	96	99	100	96	98½	100	100	96
96-7021 / CL-7021	RF Corner Sofa	100	98½	96½	96	99	100	96	98½	100	100	96
96-7022 / CL-7022	LF Corner Loveseat	75	73½	71½	71	74	75	71	73½	75	75	71
96-7023 / CL-7023	RF Corner Loveseat	75	73½	71½	71	74	75	71	73½	75	75	71

# 100 SERIES



100 Series custom sectional configuration 96-9662-1W-2K-3B right facing loveseat, 96-9660-SC-2K-3B square corner and 96-9663-1W-2K-3B left facing sofa shown here in fabric 4716-35



# 100 SERIES

Universal comfort for universal appeal. The 100 Series offers the largest selection of options plus custom sleepers and by-the-inch sofas.

sofas-by-the-inch	
sleep sofas	
seat height	22½"
seat depth	21"
frame depth	36"
overall height	36¼-38½"
seat cushions	4½" spring down
back pillows	4½" fiber down
throw pillows	20" throw pillows standard
skirts	conventional 9" high



## HOW TO CREATE YOUR MODEL NUMBER

Creating your 100 Series Selectional is as easy as 1-2-3! Start by picking the sofa, chair, sleep sofa or sectional configuration that best fits your room and your lifestyle from the 100 Series components shown on pages 18 and 19.



96-9676  
Three Cushion Sofa

For example, you've selected the **96-9676 Three Cushion Sofa**. Now, just follow these **three** simple steps:

### 1 SELECT YOUR ARM STYLE



example:  
**1F**  
Traditional Roll Arm

### 2 SELECT YOUR BACK STYLE



**2B**  
Box Back

### 3 SELECT YOUR BASE STYLE



**3F**  
Short Block Leg

You've selected the **1F** arm style with the **2B** back style and the **3F** base style. So the model number on your order should be **96-9676-1F-2B-3F**

Finally, select your fabric or leather, select your finish and add the frills (upholstery only).

Any Stickley fabric is available at no charge for contrast throw pillows. Any Grade 1 Stickley trim is available at no charge on throw pillows. Pure down/feather back cushions are available at no charge. Throw pillows are not standard on leather upholstery. All legs are maple. Multiple piece sectionals will be center-matched.

## ARM STYLES



**1A** Pleated Arm H26 W8½  
**1B** Classic Roll Arm H26½ W8½  
**1C** English Arm H26½ W6½  
**1D** Track Arm H26¼ W5  
**1E** Sock Arm H26 W9  
**1F** Traditional Roll Arm H25½ W10  
**1G** Club Arm H25¼ W5 weltless  
**1J** Flared Tuxedo Arm H31 W6¾



**1K** Rolled Tuxedo Arm H32 W7½  
**1L** Classic Roll Arm w/ Nailhead Trim H26½ W8½  
**1M** Traditional Roll Arm w/ Nailhead Trim H25½ W10  
**1P** Flared Sock Arm H27 W10  
**1W** Welted Club Arm H25¼ W5

**100 Series arms, backs and bases**  
Arm dimensions specify the height and width of one arm. Tight back options 2F and 2H not available on corner loveseats, corner sofas, or with arm styles 1J or 1K. Base option 3A not available in leather. Base options 3C, 3D, 3E, 3J not available on sleep sofas or storage ottomans. Back options 2D and 2F not available on sleep sofas. Back option 2H available on sleep sofas with 72" mattress. Base option 3W not available on all ottomans.

## BACK STYLES



**2A** Knife Edge Back  
**2B** Box Back  
**2D** Semi-Attached Pillow-Back  
**2F** Button Tight-back  
**2G** Button Box Back  
**2H** Casual Tight-back  
**2K** Tall Knife Edge Back  
**2L** Tall Box Back

## BASE STYLES



**3A** Kick Pleat Skirt  
**3B** Floating Base  
**3C** Block Leg  
**3D** Tapered Leg  
**3E** Bun Foot  
**3F** Short Block Leg  
**3G** Short Bun Foot  
**3J** Recessed Tapered Leg

**SOFAS, LOVESEATS AND CHAIRS**

**100 SERIES**

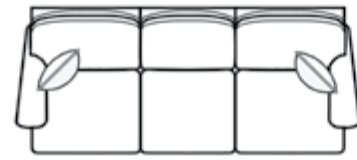

96-9676/CL-8676  
**Three Cushion Sofa**  
Outside D36 H37  
Inside L75 D21

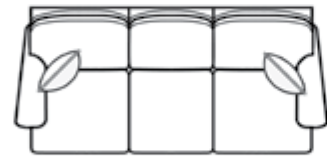

96-9677/CL-8677  
**Mid-Size Sofa**  
Outside D36 H37  
Inside L69 D21

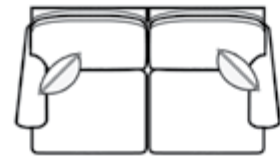

96-9675/CL-8675  
**Two Cushion Loveseat**  
Outside D36 H37  
Inside L50 D21



96-9674/CL-8674  
**One Cushion Arm Chair**  
Outside D36 H37  
Inside L22 D21

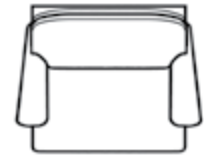

96-9674-XL/CL-8674-XL  
**Arm Chair Plus**  
Outside D36 H37  
Inside L30 D21



96-9674-SW/CL-8674-SW  
**Swivel Arm Chair**  
Outside D36 H37  
Inside L22 D21

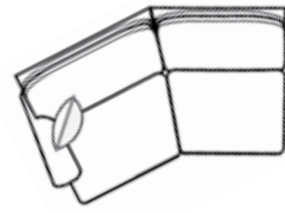

96-9661-AS/CL-8661-AS  
**Left Facing Angular Loveseat**  
Outside D48 H37  
Inside L44½ D21

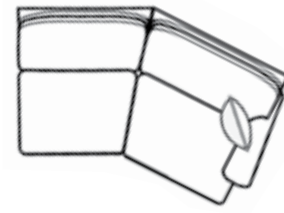

96-9662-AS/CL-8662-AS  
**Right Facing Angular Loveseat**  
Outside D48 H37  
Inside L44½ D21

**SLEEP SOFAS**

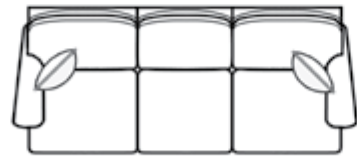

96-9511/CL-8511  
**Queen Size Sleep Sofa**  
Outside D37 H37  
Inside L70 D21

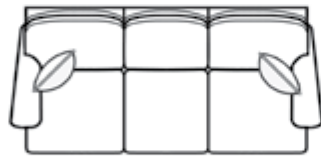

96-9510/CL-8510  
**Full Size Sleep Sofa**  
Outside D37 H37  
Inside L62 D21

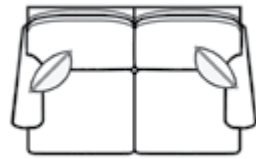

96-9509/CL-8509  
**Twin Size Sleep Sofa**  
Outside D37 H37  
Inside L50 D21

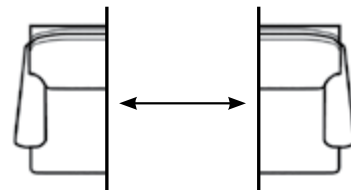

96-9678  
**"By the Inch" Sofa**  
Outside D36 H37  
Inside D21

Base options 3C, 3D, 3E, 3J not available on sleep sofas. Back options 2D and 2F not available on sleep sofas. Back option 2H available on sleep sofas with 72" mattress.

**SOFAS BY THE INCH**

Available in any length from 65" to 103". See pages 14 and 15 for more information.

**SECTIONAL COMPONENTS**

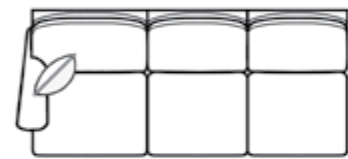

96-9663/CL-8663  
**Left Facing Sofa**  
Outside D36 H37  
Inside L75 D21

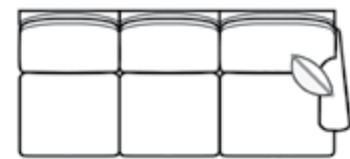

96-9664/CL-8664  
**Right Facing Sofa**  
Outside D36 H37  
Inside L75 D21

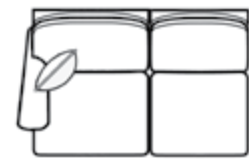

96-9661/CL-8661  
**Left Facing Loveseat**  
Outside D36 H37  
Inside L50 D21

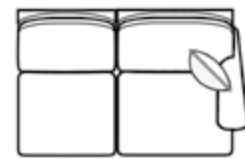

96-9662/CL-8662  
**Right Facing Loveseat**  
Outside D36 H37  
Inside L50 D21

**SECTIONAL COMPONENTS**

**100 SERIES**

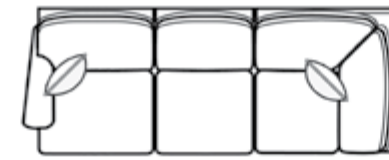

96-9665/CL-8665  
**Left Facing Corner Sofa**  
Outside D36 H37  
Inside L71 D21

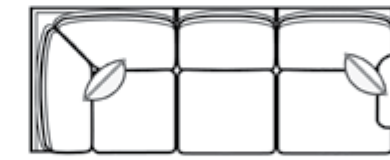

96-9666/CL-8666  
**Right Facing Corner Sofa**  
Outside D36 H37  
Inside L71 D21

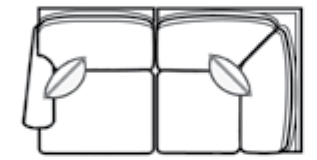

96-9667/CL-8667  
**Left Facing Loveseat**  
Outside D36 H37  
Inside L46 D21

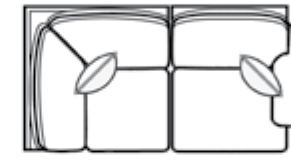

96-9668/CL-8668  
**Right Facing Loveseat**  
Outside D36 H37  
Inside L46 D21

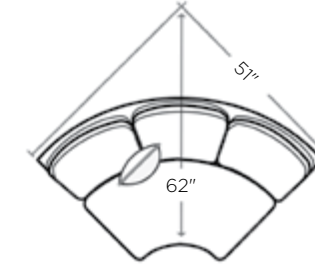

96-9660-CC/CL-8660-CC  
**Curved Corner**  
Outside D36 H37

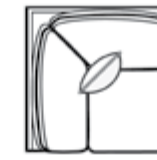

96-9660-SC/CL-8660-SC  
**Square Corner**  
Outside L36 D36 H37  
Inside L21 D21

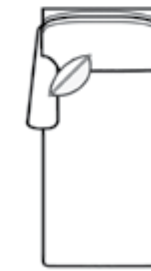

96-9670-L/CL-8670-L  
**Left Facing Chaise**  
Outside D65 H37  
Inside L25 D53

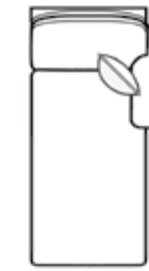

96-9670-R/CL-8670-R  
**Right Facing Chaise**  
Outside D65 H37  
Inside L25 D53

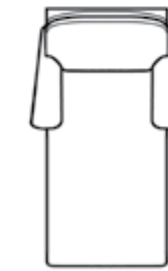

96-9671-2/CL-8671-2  
**Two Arm Chaise**  
Outside D65 H37  
Inside L23-25 D53

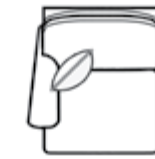

96-9672/CL-8672  
**One Cushion Left Arm Chair**  
Outside D36 H37  
Inside L25 D21



96-9673/CL-8673  
**One Cushion Right Arm Chair**  
Outside D36 H37  
Inside L25 D21

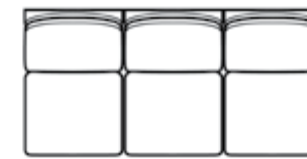

96-9669-3/CL-8669-3  
**Three Cushion Armless**  
Outside L75 D36 H37  
Inside L75 D21

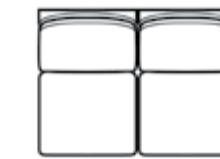

96-9669-2/CL-8669-2  
**Two Cushion Armless**  
Outside L50 D36 H37  
Inside L50 D21



96-9669-1/CL-8669-1  
**One Cushion Armless**  
Outside L25 D36 H37  
Inside L25 D21

**OUTSIDE LENGTHS BASED ON ARM STYLE**

**100 SERIES**

Component #	Description	1A	1B	1C	1D	1E	1F	1G	1J	1K	1L	1M	1P	1W
96-9661/ CL-8661	Left Facing Loveseat	58½"	58½	56½	55	59	60	55	56¾	57½	58½	60	60	55
96-9661-AS/ CL-8661-AS	Left Facing Angular Loveseat	65½	65½	63½	62	66	67	62	63¾	64½	64½	67	67	62
96-9662/ CL-8662	Right Facing Loveseat	58½	58½	56½	55	59	60	55	56¾	57½	58½	60	60	55
96-9662-AS/ CL-8662-AS	Right Facing Angular Loveseat	65½	65½	63½	62	66	67	62	63¾	64½	65½	67	67	62
96-9663/ CL-8663	Left Facing Sofa	83½	83½	81½	80	84	85	80	81¾	82½	83½	85	85	80
96-9664/ CL-8664	Right Facing Sofa	83½	83½	81½	80	84	85	80	81¾	82½	83½	85	85	80
96-9665/ CL-8665	Left Facing Corner Sofa	94½	94½	92½	91	95	96	91	92¾	93½	94½	96	96	91
96-9666/ CL-8666	Right Facing Corner Sofa	94½	94½	92½	91	95	96	91	92¾	93½	94½	96	96	91
96-9667/ CL-8667	Left Facing Corner Loveseat	69½	69½	67½	66	70	71	66	67¾	68½	69½	71	71	66
96-9668/ CL-8668	Right Facing Corner Loveseat	69½	69½	67½	66	70	71	66	67¾	68½	69½	71	71	66
96-9670-L/ CL-8670-L	Left Facing Chaise	33	33	31½	30½	33	33½	30½	31¾	33	33	33½	35	30½
96-9670-R/ CL-8670-R	Right Facing Chaise	33	33	31½	30½	33	33½	30½	31¾	33	33	33½	35	30½
96-9671-2/ CL-8671-2	Two Arm Chaise	39	39	36	34	39	39½	34	36¾	39	39	39½	43	34
96-9672/ CL-8672	One Cushion Left Arm Chair	33½	33½	31½	30	34	35	30	31¾	32½	33½	35	35	30
96-9673/ CL-8673	One Cushion Right Arm Chair	33½	33½	31½	30	34	35	30	31¾	32½	33½	35	35	30
96-9674/ CL-8674	One Cushion Arm Chair	39	39	35	32	40	42	32	35¾	37	39	42	42	32
96-9674-XL/ CL-8674-XL	One Cushion Arm Chair Plus	47	47	43	40	48	50	40	43½	45	47	50	50	40
96-9675/ CL-8675	Two Cushion Loveseat	67	67	63	60	68	70	60	63½	65	67	70	70	60
96-9676/ CL-8676	Three Cushion Sofa	92	92	88	85	93	95	85	88½	90	92	95	95	85
96-9677/ CL-8677	Mid-Size Sofa	86	86	82	79	87	89	79	82½	84	86	89	88	79
96-9509/ CL-8509	Twin-Size Sleeper	67	67	63	60	68	70	60	63½	65	67	70	70	60
96-9510/ CL-8510	Full-Size Sleeper	79	79	75	72	80	82	72	7½	77	79	82	82	72
96-9511/ CL-8511	Queen-Size Sleeper	87	87	83	80	88	90	80	83½	85	87	90	90	80

All component sizes are approximate and will vary slightly based on the thickness of fabric used and the human variables of fine hand craftsmanship.

**OTTOMANS**

**100 SERIES**

Ottomans may be specified with base styles to match your Selectional. Specify the ottoman size and add the desired base style.



96-9679-4242  
CL-8679-4242  
**Ottoman**  
L42 D42 H19



96-9679-3636  
CL-8679-3636  
**Ottoman**  
L36 D36 H19



96-9679-4825  
CL-8679-4825  
**Ottoman**  
L48 D25 H19

Also available as storage ottoman  
96-9679-4825-ST



96-9679-3625  
CL-8679-3625  
**Ottoman**  
L36 D25 H19

Also available as storage ottoman  
96-9679-3625-ST



96-9679-2522  
CL-8679-2522  
**Ottoman**  
L25 D22 H19

For example, **96-9679-2522-3C Ottoman** specifies the **3C** from the base style choices on page 9. Finally, select your fabric or leather and then select your finish.



**example:**  
**3C**  
Block Leg

All ottomans have a tight seat design. Decorative leather seams with single button is standard on leather ottomans CL-8679-3636 and CL-8679-4242. Base option 3A not available on all ottomans. Base options 3C, 3D, 3E and 3J not available on storage ottomans.

**SLEEP SOFAS**



96-9511-1F-2A-3G sleep sofa shown in fabric 3405-55

Finally, a sleep sofa so luxurious and beautifully tailored that your guests won't know it's a sleeper, unless you want them to! Legendary Stickley comfort and a world of design and tailoring choices let you create a deluxe sleep sofa worthy of any room in your home.

Add the optional 11" thick Air Dream™ mattress or our new memory foam mattress and your Selectionals sleep sofa might just be the most comfortable bed in the house!

All Stickley sleep sofas feature the finest quality sleeper mechanism which includes a locking TV headrest and a 5" thick premium quality innerspring mattress. Selectionals sleep sofas are available with all 100 Series arm styles and most back styles and base styles. 2F button tightback, 3C block leg, 3D tapered leg and 3E bun foot options are not available on sleep sofas.

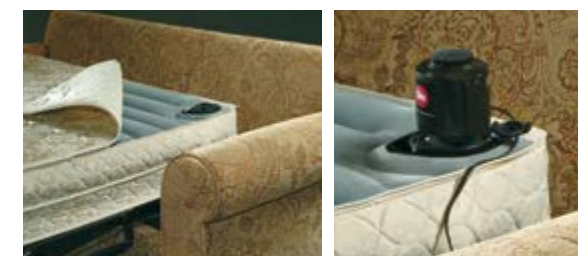

The optional Air Dream™ mattress inflates in seconds to provide the same plush dimensions and luxury feel of the finest premium mattress. Pump is included.

Creating your own Sofa-by-the-inch is as easy as 1-2-3-4!  
Start with the Sofa-by-the-inch model number  
**96-9678 “By the Inch” Sofa**

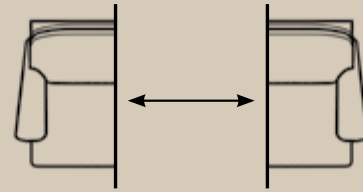

96-9678  
“By the Inch” Sofa  
Outside D36 H37 Inside D21  
Available in any length from 65” to 103”

Now, just follow these **four** simple steps:

**1 SELECT YOUR ARM STYLE**



example:  
**1F**  
Traditional Roll Arm

**2 SELECT YOUR BACK STYLE**



**2B**  
Box Back

**3 SELECT YOUR BASE STYLE**



**3F**  
Short Block Leg

**4 SELECT YOUR CUSTOM LENGTH**

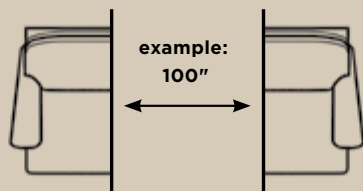

You’ve selected the **1F** arm style with the **2B** back style and the **3F** base style. You’ve also selected your custom length to be **100** inches. So the model number on your order should be **96-9678-1F-2B-3F-100**

Finally, select your fabric, select your finish and add the frills.

This chart provides all Sofa-by-the-inch inside length possibilities based on each outside length and arm style. Use the color key at the bottom of the page to determine how many seat cushions your sofa will have.

Outside length	1A	1B	1C	1D	1E	1F	1G	1J	1K	1P
65"	48	48	52	55	47	45	55	51½	50	45
66	49	49	53	56	48	46	56	52½	51	46
67	50	50	54	57	49	47	57	53½	52	47
68	51	51	55	58	50	48	58	54½	53	48
69	52	52	56	59	51	49	59	55½	54	49
70	53	53	57	60	52	50	60	56½	55	50
71	54	54	58	61	53	51	61	57½	56	51
72	55	55	59	62	54	52	62	58½	57	52
73	56	56	60	63	55	53	63	59½	58	53
74	57	57	61	64	56	54	64	60½	59	54
75	58	58	62	65	57	55	65	61½	60	55
76	59	59	63	66	58	56	66	62½	61	56
77	60	60	64	67	59	57	67	63½	62	57
78	61	61	65	68	60	58	68	64½	63	58
79	62	62	66	69	61	59	69	65½	64	59
80	63	63	67	70	62	60	70	66½	65	60
81	64	64	68	71	63	61	71	67½	66	61
82	65	65	69	72	64	62	72	68½	67	62
83	66	66	70	73	65	63	73	69½	68	63
84	67	67	71	74	66	64	74	70½	69	64
85	68	68	72	75	67	65	75	71½	70	65
86	69	69	73	76	68	66	76	72½	71	66
87	70	70	74	77	69	67	77	73½	72	67
88	71	71	75	78	70	68	78	74½	73	68
89	72	72	76	79	71	69	79	75½	74	69
90	73	73	77	80	72	70	80	76½	75	70
91	74	74	78	81	73	71	81	77½	76	71
92	75	75	79	82	74	72	82	78½	77	72
93	76	76	80	83	75	73	83	79½	78	73
94	77	77	81	84	76	74	84	80½	79	74
95	78	78	82	85	77	75	85	81½	80	75
96	79	79	83	86	78	76	86	82½	81	76
97	80	80	84	87	79	77	87	83½	82	77
98	81	81	85	88	80	78	88	84½	83	78
99	82	82	86	89	81	79	89	85½	84	79
100	83	83	87	90	82	80	90	86½	85	80
101	84	84	88	91	83	81	91	87½	86	81
102	85	85	89	92	84	82	92	88½	87	82
103	86	86	90	93	85	83	93	89½	88	83

☐ 2 CUSHIONS    ■ 3 CUSHIONS    ■ 4 CUSHIONS

# 200 SERIES



# 200 SERIES

Deeper frames, opulent seating. Larger designs for larger rooms include additional standard throw pillows.

seat height	21½"
seat depth	24"
frame depth	40"
overall height	36½-39¾"
seat cushions	6" spring down
back pillows	5½" fiber down
throw pillows	20" throw pillows standard



## HOW TO CREATE YOUR MODEL NUMBER

Creating your 200 Series Selection is as easy as 1-2-3! Start by picking the sofa, chair or sectional configuration that best fits your room and your lifestyle from the 200 Series components shown on pages 28 and 29.



96-9698  
Three Cushion Sofa

For example, you've selected the **96-9698 Three Cushion Sofa**. Now, just follow these **three** simple steps:

**1** SELECT YOUR ARM STYLE

**1F**  
Traditional Roll Arm

**2** SELECT YOUR BACK STYLE

**2B**  
Box Back

**3** SELECT YOUR BASE STYLE

**3F**  
Short Block Leg

You've selected the **1F** arm style with the **2B** back style and the **3F** base style. So the model number on your order should be **96-9698-1F-2B-3F**

Finally, select your fabric or leather, select your finish and add the frills (upholstery only).

Any Stickley fabric is available at no charge for contrast throw pillows. Any Grade 1 Stickley trim is available at no charge on throw pillows. Pure down/feather back cushions are available at no charge. Throw pillows are not standard on leather upholstery. All legs are maple. Multiple piece sectionals will be center-matched.

## ARM STYLES



**1A** Pleated Arm H26 W9½  
**1B** Classic Roll Arm H26½ W8½  
**1C** English Arm H26½ W6½  
**1D** Track Arm H26¼ W5  
**1E** Sock Arm H26 W9



**1F** Traditional Arm Roll H25½ W10  
**1G** Weltd Club Arm H25¼ W5½  
**1L** Classic Roll Arm w/ Nailhead Trim H26½ W9½  
**1M** Traditional Roll Arm w/ Nailhead Trim H25½ W10  
**1N** Sock Arm with "T" cushion H26 W9

## BACK STYLES



**2A** Knife Edge Back  
**2B** Box Back  
**2C** Multi Pillow Back  
**2J** Double Box Back  
**2K** Tall Knife Edge Back  
**2L** Tall Box Back

## BASE STYLES



**3A** Kick Pleat Skirt  
**3B** Floating Base  
**3C** Block Leg  
**3F** Short Block Leg  
**3G** Bun Foot  
**3J** Recessed Tapered Leg

## 200 SERIES

### Multi-pillow back option number of pillows

	24" 22"
Full-size Sofas and Three-cushion Sectionals	5 2
Mid-size Sofas	4 2
Loveseats and Two-cushion Sectionals	3 2
Single-cushion Sectionals	2
Curved Corner	4 2
Square Corner	3
Corner Sofa	6 3
Corner Loveseat	4 2

### 200 Series arms, backs and bases

Arm dimensions specify the height and width of one arm. Back options 2C, 2J and base style 3A not available in leather. 2J back option not available on the Arm Chair or Arm Chair Plus.

**SOFAS, LOVESEATS AND CHAIRS**

**200 SERIES**



96-9698/CL-8698  
**Three Cushion Sofa**  
Outside D40 H38  
Inside L75 D24  
D21 to kidney pillow

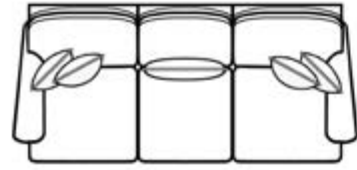

96-9696/CL-8696  
**Mid-Size Sofa**  
Outside D40 H38  
Inside L70 D24  
D21 to kidney pillow

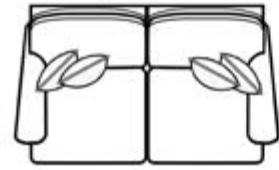

96-9695/CL-8695  
**Two Cushion Loveseat**  
Outside D40 H38  
Inside L50 D24



96-9694/CL-8694  
**One Cushion Arm Chair**  
Outside D38 H38  
Inside L23 D22

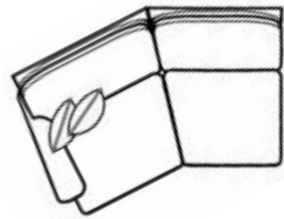

96-9681-AS/CL-8681-AS  
**Left Facing Angular Loveseat**  
Outside D52 H38  
Inside L44½ D24

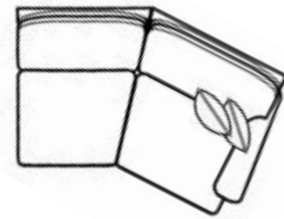

96-9682-AS/CL-8682-AS  
**Right Facing Angular Loveseat**  
Outside D52 H38  
Inside L44½ D24

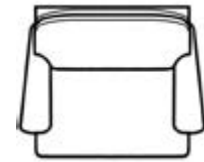

96-9694-XL/CL-8694-XL  
**Arm Chair Plus**  
Outside D38 H38  
Inside L31 D22



96-9694-SW/CL-8694-SW  
**Swivel Arm Chair**  
Outside D38 H38  
Inside L23 D22

**SECTIONAL COMPONENTS**

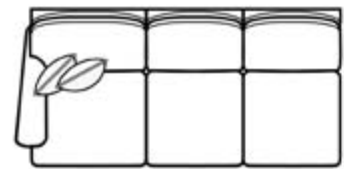

96-9683/CL-8683  
**Left Facing Sofa**  
Outside D40 H38  
Inside L75 D24

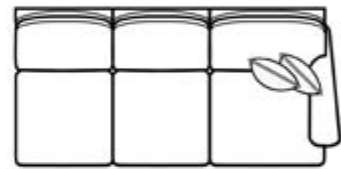

96-9684/CL-8684  
**Right Facing Sofa**  
Outside D40 H38  
Inside L75 D24



96-9681/CL-8681  
**Left Facing Loveseat**  
Outside D40 H38  
Inside L50 D24

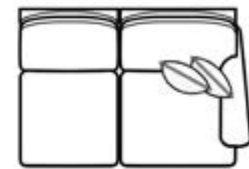

96-9682/CL-8682  
**Right Facing Loveseat**  
Outside D40 H38  
Inside L50 D24

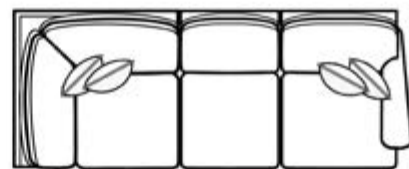

96-9686/CL-8686  
**Right Facing Corner Sofa**  
Outside D40 H38  
Inside L71 D24

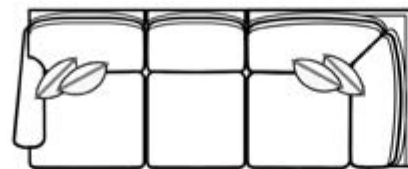

96-9685/CL-8685  
**Left Facing Corner Sofa**  
Outside D40 H38  
Inside L71 D24

**SECTIONAL COMPONENTS**

**200 SERIES**

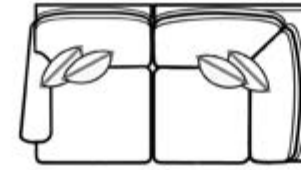

96-9687/CL-8687  
**Left Facing Corner Loveseat**  
Outside D40 H38  
Inside L46 D24

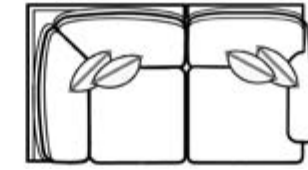

96-9688/CL-8688  
**Right Facing Corner Loveseat**  
Outside D40 H38  
Inside L46 D24

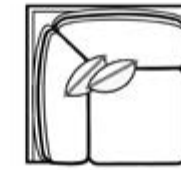

96-9697-SC/CL-8697-SC  
**Square Curved Corner**  
Outside D40 H38  
Inside L24 D24

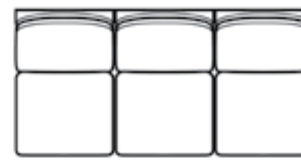

96-9689-3/CL-8689-3  
**Three Cushion Armless**  
Outside L75 D40 H38  
Inside L75 D24

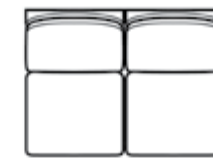

96-9689-2/CL-8689-2  
**Two Cushion Armless**  
Outside L50 D40 H38  
Inside L50 D24



96-9689-1/CL-8689-1  
**One Cushion Armless**  
Outside L25 D40 H38  
Inside L25 D24

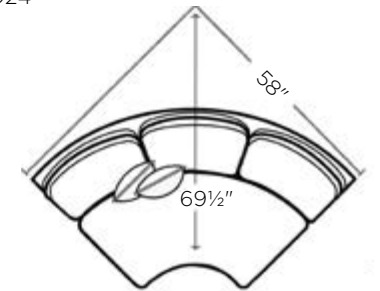

96-9697-CC/CL-8697-CC  
**Curved Corner**  
Outside D40 H38

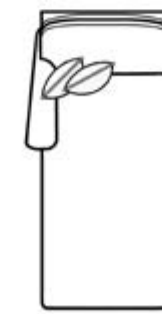

96-9690-L/CL-8690-L  
**Left Facing Chaise**  
Outside D75 H38  
Inside L27 D56

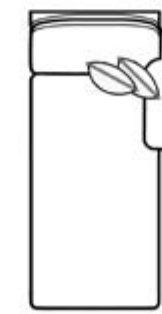

96-9690-R/CL-8690-R  
**Right Facing Chaise**  
Outside D75 H38  
Inside L27 D56

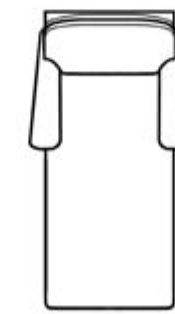

96-9691-2/CL-8691-2  
**Two Arm Chaise**  
Outside D75 H38  
Inside L24 D56



96-9692/CL-8692  
**One Cushion Left Arm Chair**  
Outside D40 H38  
Inside L25 D24



96-9693/CL-8693  
**One Cushion Right Arm Chair**  
Outside D40 H38  
Inside L25 D24

All 200 Series components are 40" deep (except 9694/8694 chair).  
Seat heights are 21½". Outside lengths vary based on arm style.  
See outside dimensions chart on page 22. Overall height is determined by back style.

**OUTSIDE LENGTHS BASED ON ARM STYLE**

**200 SERIES**

Component #	Description	1A	1B	1C	1D	1E	1F	1G	1L	1M	1N
96-9681/ CL-8681	Left Facing Loveseat	59½"	59½	56½	55½	59	60	55½	59½	60	59
96-9681-AS/ CL-8681-AS	Left Facing Angular Loveseat	66½	66½	63½	62½	66	67	62½	66½	67	66
96-9682/ CL-8682	Right Facing Loveseat	59½	59½	56½	55½	59	60	55½	59½	60	59
96-9682-AS/ CL-8682-AS	Right Facing Angular Loveseat	66½	66½	63½	62½	66	67	62½	66½	67	66
96-9683/ CL-8683	Left Facing Sofa	84½	84½	81½	80½	84	85	80½	84½	85	84
96-9684/ CL-8684	Right Facing Sofa	84½	84½	81½	80½	84	85	80½	84½	85	84
96-9685/ CL-8685	Left Facing Corner Sofa	100½	100½	97½	96½	100	101	96½	100½	101	100
96-9686/ CL-8686	Right Facing Corner Sofa	100½	100½	97½	96½	100	101	96½	100½	101	100
96-9687/ CL-8687	Left Facing Corner Loveseat	75½	75½	72½	71½	75	76	71½	75½	76	75
96-9688/ CL-8688	Right Facing Corner Loveseat	75½	75½	72½	71½	75	76	71½	75½	76	75
96-9690-L/ CL-8690-L	Left Facing Chaise	36	36	33	32½	35	36	32½	36	36	35
96-9690-R/ CL-8690-R	Right Facing Chaise	36	36	33	32½	35	36	32½	36	36	35
96-9691-2/ CL-8691-2	Two Arm Chaise	43	43	37	36	41	43	36	43	43	41
96-9692/ CL-8692	One Cushion Left Arm Chair	34½	34½	31½	30½	34	35	30½	34½	35	34
96-9693/ CL-8693	One Cushion Right Arm Chair	34½	34½	31½	30½	34	35	30½	34½	35	34
96-9694/ CL-8694	One Cushion Arm Chair	42	42	36	34	41	43	34	42	43	41
96-9694-XL/ CL-8694-XL	One Cushion Arm Chair Plus	49	49	43	41	48	50	41	49	50	48
96-9695/ CL-8695	Two Cushion Loveseat	69	69	63	61	68	70	61	69	70	68
96-9696/ CL-8696	Mid-Size Sofa	89	89	83	81	88	90	81	89	90	88
96-9698/ CL-8698	Three Cushion Sofa	94	94	88	86	93	95	86	94	95	93

All component sizes are approximate and will vary slightly based on the thickness of fabric used and the human variables of fine hand craftsmanship.

**OTTOMANS**

**200 SERIES**

Creating your **200 Series ottoman model number** is as easy as 1-2-3! Start by picking the desired size from the choices shown below.



96-9699-4242/  
CL-8699-4242  
**Ottoman**  
L42 D42 H18



96-9699-3636/  
CL-8699-3636  
**Ottoman**  
L36 D36 H18

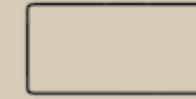

96-9699-4825/  
CL-8699-4825  
**Ottoman**  
L48 D25 H18



96-9699-3625/  
CL-8699-3625  
**Ottoman**  
L36 D25 H18



96-9699-2522/  
CL-8699-2522  
**Ottoman**  
L25 D22 H18

For example, you've selected the **96-9699-2522 Ottoman** from the choices shown above.



96-9699-2522  
**Ottoman**

To finish, just **select your base style**



**example:**  
**3C**  
Block Leg

You've selected the **3C** base style. So the model number on your order should be **96-9699-2522-3C**

Finally, select your fabric or leather and then select your finish.

All ottomans have a tight seat design. Decorative leather seams with single button is standard on leather ottomans CL-8699-3636 and CL-8699-4242.



# 300 SERIES



300 Series custom sectional configuration 96-9775-R-1X-2B-3W Left Corner Sofa,  
96-9765-3-2B-3W Three Cushion Armless Sofa and 96-9766-L-1X-2B-3W  
Right Facing Chaise shown in fabric 4703-75

# 300 SERIES

Low, sophisticated and contemporary. Clean, modern style elements include armless and waterfall skirt options.

seat height	20"
seat depth	24"
frame depth	38"
overall height	31-33"
seat cushions	6" spring down
back pillows	4" fiber down
throw pillows	24" throw pillows standard
skirts	waterfall skirt options



300 Series sofa shown here with bench seat option

## HOW TO CREATE YOUR MODEL NUMBER

Creating your 300 Series Selection is as easy as 1-2-3! Start by picking the sofa, chair or sectional configuration that best fits your room and your lifestyle from the 300 Series components shown on pages 36 and 37.



96-9773  
Three Cushion Sofa

For example, you've selected the **96-9773 Three Cushion Sofa**. Now, just follow these **three** simple steps:

### 1 SELECT YOUR ARM STYLE



**example:**  
**1V**  
Flared Tufted Arm

### 2 SELECT YOUR BACK STYLE



**2B**  
Box Back

### 3 SELECT YOUR BASE STYLE



**3W**  
Waterfall Skirt

You've selected the **1V** arm style with the **2B** back style and the **3W** base style. So the model number on your order should be **96-9773-1V-2B-3W**

Finally, select your fabric or leather, select your finish and add the frills (upholstery only).

## ARM STYLES



**1A** Pleated Arm H24¼ W6¾  
**1Q** Wide Track Arm H21 W8  
**1R** Conversation Arm H28 W8  
**1S** Narrow Track Arm H24 W3  
**1U** Sloped Track Arm H24¼ W4¾  
**1V** Flared Tufted Arm H28 W5½  
**1X** Armless

## 300 SERIES

## BACK STYLES



**2A** Knife Edge Back  
**2B** Box Back  
**2E** Tight Back  
**Bench seat option**  
Specify "-bench seat" after your model number. For example, 96-9773-1R-2B-3B-Bench Seat. Not available in leather. Railroaded fabrics recommended.

## BASE STYLES



**3A** Conventional Skirt  
**3B** Floating Base  
**3HW** Wide Leg  
**3HM** Medium Leg  
**3HN** Narrow Leg  
**3W** Waterfall Skirt

Tight back option 2E is not available on corner sofas and loveseats. 3A conventional skirt and 3W waterfall skirt not available in leather. 3HW wide leg is recommended with arm styles 1Q and 1R. 3HM medium leg is recommended with arm styles 1A, 1U and 1V. 3HN narrow leg recommended with arm style 1S. Ottomans not available with base option 3W.

**SOFAS, LOVESEATS AND CHAIRS**

**300 SERIES**

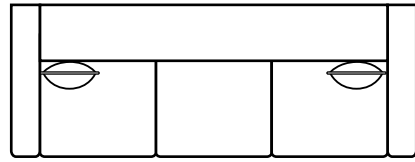

96-9773/CL-8773  
**Three Cushion Sofa**  
Outside D38  
Inside L87 D24

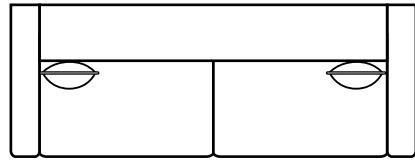

96-9777/CL-8777  
**Two Cushion Sofa**  
Outside D38  
Inside L87 D24

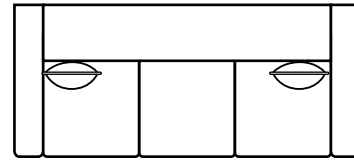

96-9771/CL-8771  
**Three Cushion Mid-Size Sofa**  
Outside D38  
Inside L72 D24

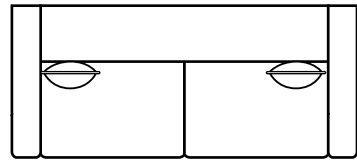

96-9772/CL-8772  
**Two Cushion Mid-Size Sofa**  
Outside D38  
Inside L72 D24

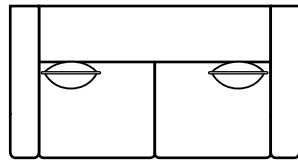

96-9770/CL-8770  
**Two Cushion Loveseat**  
Outside D38  
Inside L58 D24

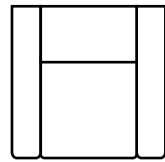

96-9769/CL-8769  
**One Cushion Arm Chair**  
Outside D38  
Inside L24 D24

**SECTIONAL COMPONENTS**

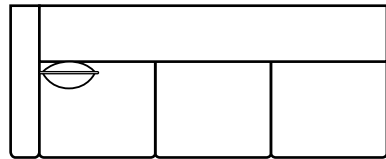

96-9760/CL-8760  
**Left Facing Sofa**  
Outside D38  
Inside L87 D24

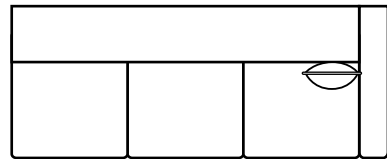

96-9761/CL-8761  
**Right Facing Sofa**  
Outside D38  
Inside L87 D24

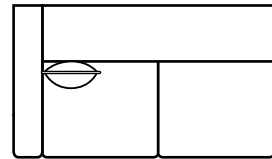

96-9762/CL-8762  
**Left Facing Loveseat**  
Outside D38  
Inside L58 D24

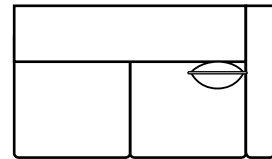

96-9763/CL-8763  
**Right Facing Loveseat**  
Outside D38  
Inside L58 D24

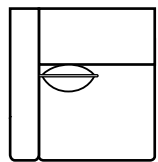

96-9767/CL-8767  
**One Cushion Left Arm Chair**  
Outside D38  
Inside L29 D24

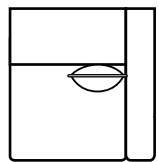

96-9768/CL-8768  
**One Cushion Right Arm Chair**  
Outside D38  
Inside L29 D24

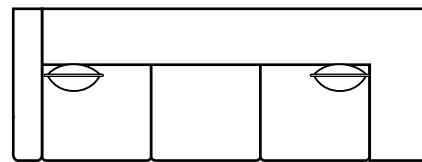

96-9775-L/CL-8775-L  
**Left Corner Sofa**  
Outside D38  
Inside L82 D24

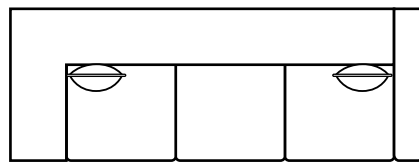

96-9775-R/CL-8775-R  
**Right Corner Sofa**  
Outside D38  
Inside L82 D24

All component sizes are approximate and will vary slightly based on the thickness of fabric used and the human variables of fine hand craftsmanship. Tightback option 2E is not available on corner sofas and loveseats. Throw pillows not standard in leather. Outside heights vary based on back style (2A knife edge back and 2B box back pillow are 33" high, 2E tightback is 31" high). Outside lengths vary based on arm style. See outside length chart on page 30. Overall height is determined by back style.

**SECTIONAL COMPONENTS**

**300 SERIES**

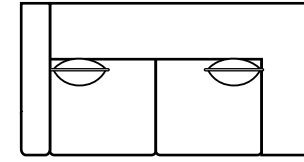

96-9776-L/CL-8776-L  
**Left Corner Loveseat**  
Outside D38  
Inside L53 D24

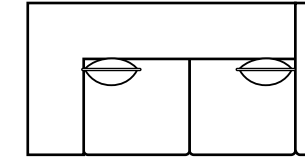

96-9776-R/CL-8776-R  
**Right Corner Loveseat**  
Outside D38  
Inside L53 D24

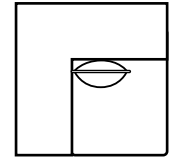

96-9764/CL-8764  
**Square Corner Section**  
Outside L38 D38  
Inside L24 D24

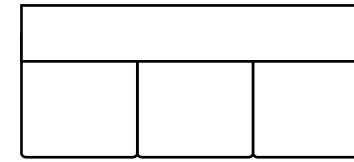

96-9765-3/CL-8765-3  
**Three Cushion Armless**  
Outside L87 D38  
Inside L87 D24



96-9765-2/CL-8765-2  
**Two Cushion Armless**  
Outside L58 D38  
Inside L58 D24



96-9765-1/CL-8765-1  
**One Cushion Armless**  
Outside L38 D38  
Inside L29 D24



**300 Series armless options**

In addition to the armless components to the left, any of the mid-size sofa, corner sofa, and chaise components in the 300 Series are available without arms. Specify arm option 1X. For example, 96-9773-1X-2B-3W shown above. Please note that armless components do not include throw pillows.

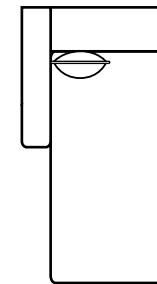

96-9766-L/CL-8766-L  
**Left Facing Chaise**  
Outside D69  
Inside L29 D58

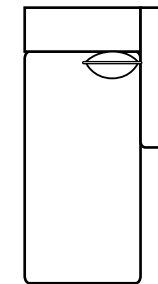

96-9766-R/CL-8766-R  
**Right Facing Chaise**  
Outside D69  
Inside L29 D58

**OUTSIDE LENGTHS BASED ON ARM STYLE**

**300 SERIES**

Component #	Description	1A	1Q	1R	1S	1U	1V	1X
96-9760/ CL-8760	Left Facing Sofa	93¾"	95	95	90	91¾	92½	87
96-9761/ CL-8761	Right Facing Sofa	93¾	95	95	90	91¾	92½	87
96-9762/ CL-8762	Left Facing Loveseat	64¾	66	66	61	62¾	63½	58
96-9763/ CL-8763	Right Facing Loveseat	64¾	66	66	61	62¾	63½	58
96-9764/ CL-8764	Square Corner Section	38	38	38	38	38	38	38
96-9765-1/ CL-8765-1	One Cushion Armless	29	29	29	29	29	29	29
96-9765-2/ CL-8765-2	Two Cushion Armless	58	58	58	58	58	58	58
96-9765-3/ CL-8765-3	Three Cushion Armless	87	87	87	87	87	87	87
96-9766-L/ CL-8766-L	Left Facing Chaise	35¾	37	37	32	33¾	34½	29
96-9766-R/ CL-8766-R	Right Facing Chaise	35¾	37	37	32	33¾	34½	29
96-9767/ CL-8767	One Cushion Left Arm Chair	35¾	37	37	32	33¾	34½	29
96-9768/ CL-8768	One Cushion Right Arm Chair	35¾	37	37	32	33¾	34½	29
96-9769/ CL-8769	One Cushion Arm Chair	37½	40	40	30	33½	35	24
96-9770/ CL-8770	Two Cushion Loveseat	71½	74	74	64	67½	69	58
96-9771/ CL-8771	Three Cushion Mid-Size Sofa	85½	88	88	78	81½	83	72
96-9772/ CL-8772	Two Cushion Mid-Size Sofa	85½	88	88	78	81½	83	72
96-9773/ CL-8773	Three Cushion Sofa	100½	103	103	93	96½	98	87
96-9775-L/ CL-8775-L	Left Corner Sofa	102¾	104	104	100	100¾	101½	96
96-9775-R/ CL-8775-R	Right Corner Sofa	102¾	104	104	100	100¾	101½	96
96-9776-L/ CL-8776-L	Left Corner Loveseat	73¾	75	75	71	71¾	72½	67
96-9776-R/ CL-8776-R	Right Corner Loveseat	73¾	75	75	71	71¾	72½	67
96-9777/ CL-8777	Two Cushion Sofa	100½	103	103	93	96½	98	87

All component sizes are approximate and will vary slightly based on the thickness of fabric used and the human variables of fine hand craftsmanship.

**OTTOMANS**

**300 SERIES**

Creating your **300 Series ottoman model number** is as easy as 1-2-3! Start by picking the size from the choices shown below.



96-9774-4242  
CL-8774-4242  
**Ottoman**  
L42 D42 H17



96-9774-6425  
CL-8774-6425  
**Ottoman**  
L64 D25 H17



96-9774-3636  
CL-8774-3636  
**Ottoman**  
L36 D36 H17

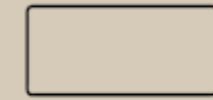

96-9774-4825  
CL-8774-4825  
**Ottoman**  
L48 D25 H17



96-9774-3625  
CL-8774-3625  
**Ottoman**  
L36 D25 H17



96-9774-2925  
CL-8774-2925  
**Ottoman**  
L29 D25 H17



96-9774-2522  
CL-8774-2522  
**Ottoman**  
L25 D22 H17

For example, you've selected the **96-9774-2925 Ottoman** from the choices shown above.

To finish, just **select your base style**



**example:**  
**3HW**  
Wide Leg

You've selected the **3HW** base style. So the model number on your order should be **96-9774-2925-3HW**

Finally, select your fabric or leather and then select your finish.

All ottomans have a tight seat design. Decorative leather seams with single button is standard on leather ottomans CL-8774-3636 and CL-8774-4242.

# 400 SERIES



Only Stickley lets you put a motion seat anywhere you want it in your sofa, loveseat or sectional. The 400 Series sofas, loveseats, chairs and sectional components keep their reclining function a carefully hidden secret. Fully finished backs and the “zero-clearance” ability to place your sofa or chair tight against the wall, means that these impeccably tailored, custom designs don’t look like motion furniture. That is, of course, until you activate the simple, infinite-position switch concealed between the cushion and the arm, and the ultra-high quality, motorized mechanism glides you silently into your own “Comfort Zone”. And, these fully supportive, high back styles are also available as conventional stationary upholstery.

# 400 SERIES

Custom motion upholstery that doesn't look like motion and provides incliner seating wherever you want it.

motion units	
seat height	20½"
seat depth	21"
frame depth	41"
overall height	40½-42¼"
seat cushions	5" spring down
back pillows	5" fiber down
throw pillows	20" throw pillows standard



## HOW TO CREATE YOUR MODEL NUMBER

Creating your 400 Series Selectional is as easy as 1-2-3! Start by picking the sofa, chair or sectional configuration that best fits your room and your lifestyle from the 400 Series components shown on page 44.

For example, you've selected the **96-9812P Motion Sofa**

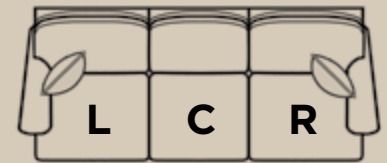

96-9812P/CL-8812P  
**Motion Sofa** L, C and R indicate motion locations

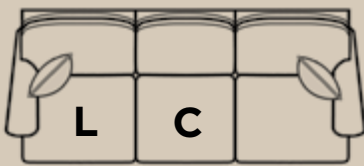

Next, select which seats you would like to recline and add those locations to your model number. For example, **96-9812P-LC** indicates you desire left (L) and center (C) motion unit locations. Then, just follow these **three** simple steps:

### 1 SELECT YOUR ARM STYLE



example:  
**1F**  
Traditional Roll Arm

### 2 SELECT YOUR BACK STYLE



**2B**  
Box Back

### 3 SELECT YOUR BASE STYLE



**3F**  
Short Block Leg

You've selected the **1F** arm style, the **2B** back style and the **3F** base style. So the model number on your order should be **96-9812P-LC-1F-2B-3F**

Finally, select your fabric or leather, select your finish and add the frills (upholstery only).

## ARM STYLES



**1E** Sock Arm H26 W8  
**1F** Traditional Roll Arm H25½ W9  
**1M** Traditional Roll Arm w/Nailhead Trim H25½ W9  
**1P** Flared Sock Arm H26 W10  
**1W** Welted Club Arm H25¼ W5¼

## BACK STYLES



**2A** Knife Edge Back  
**2B** Box Back

## BASE STYLES



**3F** Short Block Leg  
**3G** Short Bun Foot

## 400 SERIES



96-9950  
**Rechargeable Battery**  
Stickley Motion Upholstery is available with an optional rechargeable battery, that powers your reclining unit for over 200 complete cycles between charges.

Any Stickley fabric is available at no charge for contrast throw pillows. Any Grade 1 Stickley trim is available at no charge on throw pillows. Pure down/feather back cushions are available at no charge. Throw pillows are not standard on leather upholstery. All legs are maple. Multiple piece sectionals will be center-matched.

**MOTION COMPONENTS**

**400 SERIES**

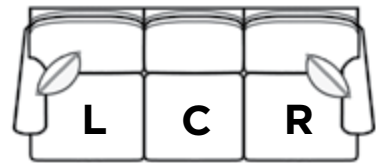

96-9812P/CL-8812P  
**Motion Sofa**  
Outside D41 H41  
Inside L71¼ D21

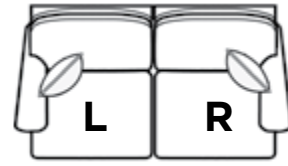

96-9813P/CL-8813P  
**Motion Loveseat**  
Outside D41 H41  
Inside L47½ D21

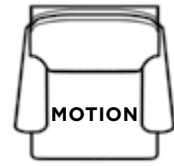

96-9814P/CL-8814P  
**Motion Chair**  
Outside D41 H41  
Inside L21¼ D21

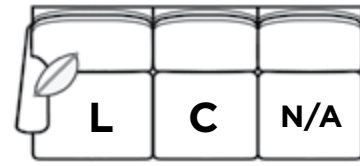

96-9815P/CL-8815P  
**Motion Left Sofa Section**  
Outside D41 H41  
Inside L71¼ D21

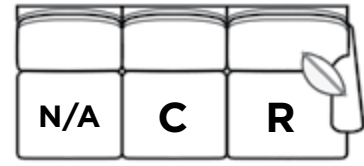

96-9816P/CL-8816P  
**Motion Right Sofa Section**  
Outside D41 H41  
Inside L71¼ D21

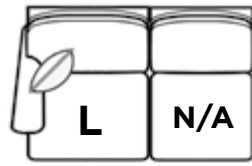

96-9817P/CL-8817P  
**Motion Left Loveseat**  
Outside D41 H41  
Inside L47½ D21

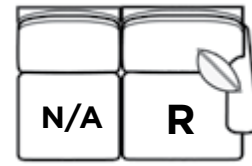

96-9818P/CL-8818P  
**Motion Right Loveseat**  
Outside D41 H41  
Inside L47½ D21

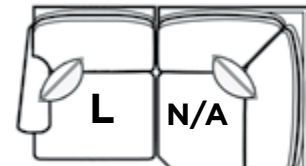

96-9828P/CL-8828P  
**Motion Left Corner Loveseat**  
Outside D44 H41  
Inside L47¾ D21

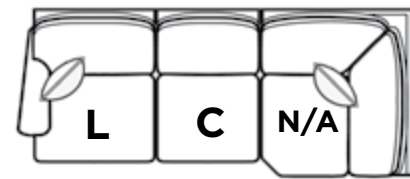

96-9826P/CL-8826P  
**Motion Left Facing Corner Sofa**  
Outside D44 H41  
Inside L71¼ D21

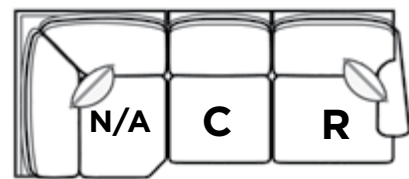

96-9827P/CL-8827P  
**Motion Right Facing Corner Sofa**  
Outside D44 H41  
Inside L71¼ D21

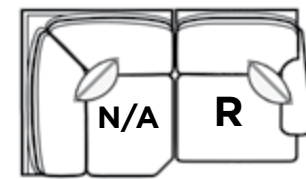

96-9829P/CL-8829P  
**Motion Right Corner Loveseat**  
Outside D44 H41  
Inside L47¾ D21

Powered motion seating is available in any of the locations noted (L, C, R). Add the motion location you desire to your model number. Due to restrictions of motion upholstery, and the need for compatibility, 400 series components are not 8-way hand knotted and cushions are nonreversible. Multiple piece sectionals will be center-matched. 96- designates fabric, CL- designates leather. Throw pillows are not standard with leather upholstery. All exposed legs are maple. Overall lengths will vary with arm selection (see outside dimensions chart on page 39). All component sizes are approximate and will vary slightly based on the thickness of fabric used and the human variables of fine hand-craftsmanship. Overall height is determined by back style.

**STATIONARY COMPONENTS**

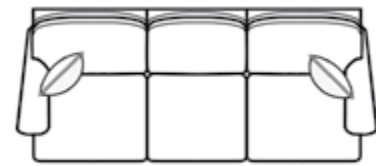

96-9812/CL-8812  
**Stationary Sofa**  
Outside D41 H41  
Inside L71¼ D21

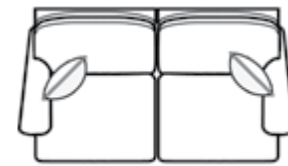

96-9813/CL-8813  
**Stationary Loveseat**  
Outside D41 H41  
Inside L47½ D21



96-9814/CL-8814  
**Stationary Chair**  
Outside D41 H41  
Inside L21½ D21

**STATIONARY COMPONENTS**

**400 SERIES**

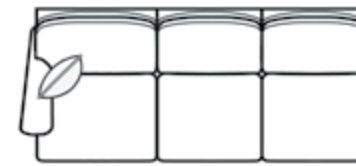

96-9815/CL-8815  
**Stationary Left Sofa Section**  
Outside D41 H41  
Inside L71¼ D21

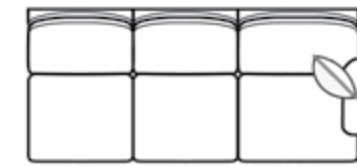

96-9816/CL-8816  
**Stationary Right Sofa Section**  
Outside D41 H41  
Inside L71¼ D21

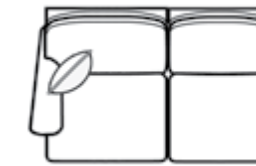

96-9817/CL-8817  
**Stationary Left Loveseat**  
Outside D41 H41  
Inside L47½ D21

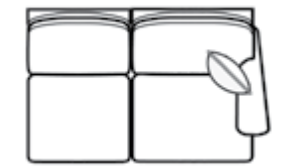

96-9818/CL-8818  
**Stationary Right Loveseat**  
Outside D41 H41  
Inside L47½ D21

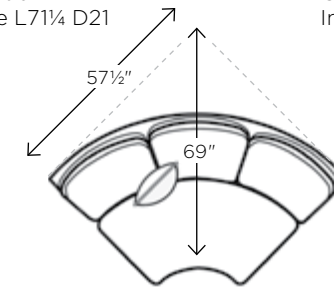

96-9820/CL-8820  
**Stationary Curved Corner Unit**  
Outside D41 H41  
Inside D21

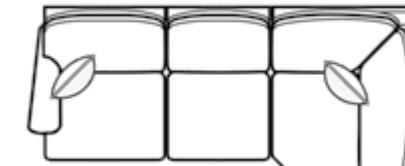

96-9826/CL-8826  
**Stationary Left Facing Corner Sofa**  
Outside D44 H41  
Inside L71¼ D21

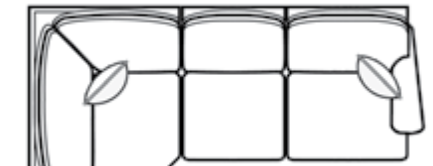

96-9827/CL-8827  
**Stationary Right Facing Corner Sofa**  
Outside D44 H41  
Inside L71¼ D21

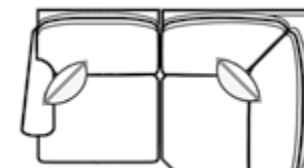

96-9828/CL-8828  
**Stationary Left Corner Loveseat**  
Outside D44 H41  
Inside L47¾ D21

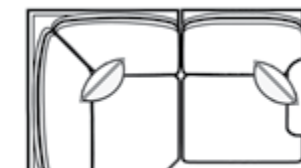

96-9829/CL-8829  
**Stationary Right Corner Loveseat**  
Outside D44 H41  
Inside L47¾ D21



96-9819/CL-8819  
**Stationary Square Corner Unit**  
Outside D44 H41  
Inside L24 D24



96-9821/CL-8821  
**Stationary Left Arm Chair**  
Outside D41 H41  
Inside L23¾ D21



96-9822/CL-8822  
**Stationary Right Arm Chair**  
Outside D41 H41  
Inside L23¾ D21

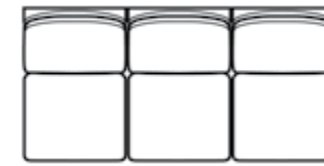

96-9825/CL-8825  
**Three Cushion Stationary Armless Section**  
Outside L71¼ D41 H41  
Inside L71¼ D21



96-9824/CL-8824  
**Two Cushion Stationary Armless Section**  
Outside L47½ D41 H41  
Inside L47½ D21



96-9823/CL-8823  
**One Cushion Stationary Armless Section**  
Outside L23¾ D41 H41  
Inside L23¾ D21

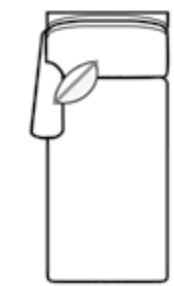

96-9830-L/CL-8830-L  
**Left Facing Chaise**  
Outside D65 H41  
Inside L23¾ D53

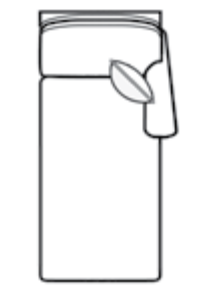

96-9830-R/CL-8830-R  
**Right Facing Chaise**  
Outside D65 H41  
Inside L23¾ D53



CL-8814-1E-2A-3G Roll Arm Chair shown in leather Glovesoft Chamois

## OUTSIDE LENGTHS BASED ON ARM STYLE

## 400 SERIES

Component #	Description	1E	1F	1M	1P	1W
96-9812/ CL-8812	Stationary Sofa	87¼"	89¼	89¼	91¼	82¾
96-9812P/ CL-8812P	Motion Sofa	87¼	89¼	89¼	91¼	82¾
96-9813/C L-8813	Stationary Loveseat	63½	65½	65½	67½	59
96-9813P/ CL-8813P	Motion Loveseat	63½	65½	65½	67½	59
96-9814/ CL-8814	Stationary Chair	37½	39½	39½	41	33
96-9814P/ CL-8814P	Motion Chair	37½	39½	39½	41	33
96-9815/ CL-8815	Left Facing Stationary Sofa	79¼	80¼	80¼	81¼	77
96-9815P/ CL-8815P	Left Facing Motion Sofa	79¼	80¼	80¼	81¼	77
96-9816/ CL-8816	Right Facing Stationary Sofa	79¼	80¼	80¼	81¼	77
96-9816P/ CL-8816P	Right Facing Motion Sofa	79¼	80¼	80¼	81¼	77
96-9817/ CL-8817	Left Facing Stationary Loveseat	55½	56½	56½	57½	53¼
96-9817P/ CL-8817P	Left Facing Motion Loveseat	55½	56½	56½	57½	53¼
96-9818/ CL-8818	Right Facing Stationary Loveseat	55½	56½	56½	57½	53¼
96-9818P/ CL-8818P	Right Facing Motion Loveseat	55½	56½	56½	57½	53¼
96-9821/ CL-8821	Left Facing Chair	31¼	32¾	32¾	33¾	29½
96-9822/ CL-8822	Right Facing Chair	31¼	32¾	32¾	33¾	29½
96-9826/ CL-8826	Left Facing Stationary Corner Sofa	99	100	100	101	96¾
96-9826P/ CL-8826P	Left Facing Motion Corner Sofa	99	100	100	101	96¾
96-9827/ CL-8827	Right Facing Stationary Corner Sofa	99	100	100	101	96¾
96-9827P/ CL-8827P	Right Facing Motion Corner Sofa	99	100	100	101	96¾
96-9828/ CL-8828	Left Facing Stationary Corner Loveseat	75¼	76¼	76¼	77¼	73
96-9828P/ CL-8828P	Left Facing Motion Corner Loveseat	75¼	76¼	76¼	77¼	73
96-9829/ CL-8829	Right Facing Stationary Corner Loveseat	75¼	76¼	76¼	77¼	73
96-9829P/ CL-8829P	Right Facing Motion Corner Loveseat	75¼	76¼	76¼	77¼	73
96-9830-L/ CL-8830-L	Left Facing Stationary Chaise	33	34	34	35	30¾
96-9830-R/ CL-8830-R	Right Facing Stationary Chaise	33	34	34	35	30¾

All component sizes are approximate and will vary slightly based on the thickness of fabric used and the human variables of fine hand craftsmanship.



# 500 SERIES



500 Series sofa 96-9845-1T-2F-3HM shown here in fabric 7537-35  
with 500 Series chair 96-9842-1TS-2H-3D shown in fabric 9327-85

# 500 SERIES

Lighter scale. Lower seating. Clean, finely scaled arm styles. Waterfall skirt and tall leg options.

sofas-by-the-inch	
seat height	20"
seat depth	20½"
frame depth	37"
overall height	36½-36¾"
seat cushions	4½" ultra plush
back pillows	3½" fiber plush
throw pillows	18" throw pillows standard



## HOW TO CREATE YOUR MODEL NUMBER

Creating your 500 Series Selectional is as easy as 1-2-3! Start by picking the sofa, chair or sectional configuration that best fits your room and your lifestyle from the 500 Series components shown on page 52 and 53



96-9845  
Three Cushion Sofa

For example, you've selected the **96-9845 Three Cushion Sofa**. Now, just follow these **three** simple steps:

**1** SELECT YOUR ARM STYLE



**example:**  
**1A**  
Pleated Arm

**2** SELECT YOUR BACK STYLE



**2B**  
Box Back

**3** SELECT YOUR BASE STYLE



**3HM**  
Medium Leg

You've selected the **1A** arm style with the **2B** back style and the **3HM** base style. So the model number on your order should be **96-9845-1A-2B-3HM**

Finally, select your fabric or leather, select your finish and add the frills (upholstery only).

Any Stickley fabric is available at no charge for contrast throw pillows. Any Grade 1 Stickley trim is available at no charge on throw pillows. Pure down/feather back cushions are available at no charge. Throw pillows are not standard on leather upholstery. All legs are maple. Multiple piece sectionals will be center-matched.







## ARM STYLES

 <b>1A</b> Pleated Arm H24 W5	 <b>1E</b> Weltd Sock Arm H24 W5	 <b>1G</b> Club Arm H23¾ W5¼ (weltless)	 <b>1S</b> Narrow Track Arm H23¾ W3¼	 <b>1T</b> Sock Arm H24 W5	 <b>1Y</b> Flared Pleat Arm H23¾ W5
 <b>1AS</b> Pleated Arm, Sloped H24 W5	 <b>1ES</b> Weltd Sock Arm, Sloped H24 W5	 <b>1GS</b> Club Arm, Sloped H23¾ W5¼ (weltless)	 <b>1SS</b> Narrow Track Arm, Sloped H23¾ W3¼	 <b>1TS</b> Sock Arm, Sloped H24 W5	 <b>1YS</b> Flared Pleat Arm, Sloped H23¾ W5

## BACK STYLES

					<p><b>500 Series</b></p> <p>Pillow backs H36½. Tight backs H36¾. Base options 3A and 3W not available in leather. Back options 2F and 2H not available on corner sofas and loveseats.</p>
<b>2A</b> Knife Edge Back	<b>2B</b> Box Back	<b>2G</b> Buttoned Box Back	<b>2F</b> Buttoned Tight Back	<b>2H</b> Casual Tight Back	

## BASE STYLES

						
<b>3A</b> Skirted	<b>3B</b> Floating Base	<b>3D</b> 6" Tapered Leg	<b>3HN</b> Narrow Leg	<b>3HM</b> Medium Leg	<b>3T</b> Turned Leg	<b>3W</b> Waterfall Skirt

## 500 SERIES

**SOFAS, LOVESEATS AND CHAIRS**

**500 SERIES**



96-9845/CL-8845  
**Three Cushion Sofa**  
Outside D37  
Inside L74¼ D20½

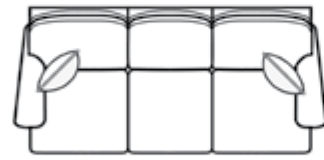

96-9844/CL-8844  
**Mid-Size Sofa**  
Outside D37  
Inside L66¼ D20½

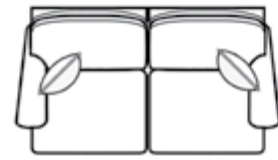

96-9843/CL-8843  
**Two Cushion Loveseat**  
Outside D37  
Inside L49½ D20½



96-9842/CL-8842  
**One Cushion Arm Chair**  
Outside D37  
Inside L21¼ D20½

**SECTIONAL COMPONENTS**

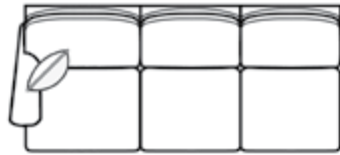

96-9833/CL-8833  
**Left Facing Sofa**  
Outside D37  
Inside L74¼ D20½

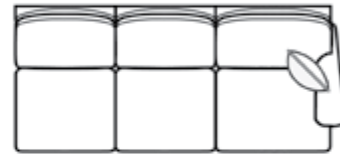

96-9834/CL-8834  
**Right Facing Sofa**  
Outside D37  
Inside L74¼ D20½

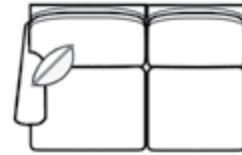

96-9831/CL-8831  
**Left Facing Loveseat**  
Outside D37  
Inside L49½ D20½

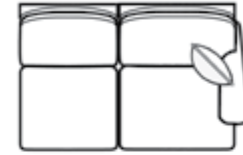

96-9832/CL-8832  
**Right Facing Loveseat**  
Outside D37  
Inside L49½ D20½

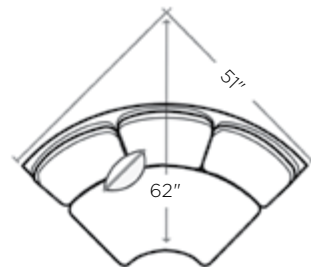

96-9837-CC/CL-8837-CC  
**Curved Corner**  
Outside D37



96-9835/CL-8835  
**Left Facing Corner Sofa**  
Outside D37  
Inside L70½ D20½



96-9836/CL-8836  
**Right Facing Corner Sofa**  
Outside D37  
Inside L70½ D20½



96-9837-SC/CL-8837-SC  
**Square Corner**  
Outside L36 D36  
Inside D20½

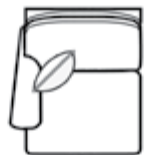

96-9840/CL-8840  
**One Cushion Left Arm Chair**  
Outside D37  
Inside L24¾ D20½



96-9841/CL-8841  
**One Cushion Right Arm Chair**  
Outside D37  
Inside L24¾ D20½

**SECTIONAL COMPONENTS**

**500 SERIES**

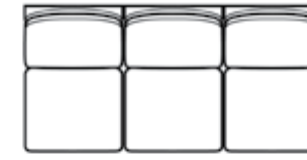

96-9838-3/CL-8838-3  
**Three Cushion Armless**  
Outside L75 D37  
Inside L75 D20½

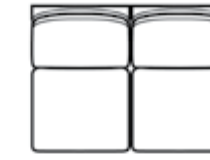

96-9838-2/CL-8838-2  
**Two Cushion Armless**  
Outside L50 D37  
Inside L50 D20½



96-9838-1/CL-8838-1  
**One Cushion Armless**  
Outside L25 D37  
Inside L25 D20½

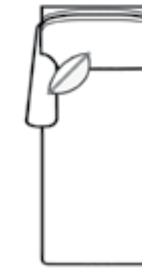

96-9839-L/CL-8839-L  
**Left Facing Chaise**  
Outside D69  
Inside L24¾ D53

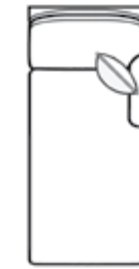

96-9839-R/CL-8839-R  
**Right Facing Chaise**  
Outside D69  
Inside L24¾ D53

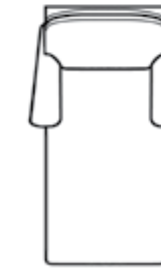

96-9839-2/CL-8839-2  
**Two Arm Chaise**  
Outside D69  
Inside L24¾ D53

**SOFAS BY THE INCH**

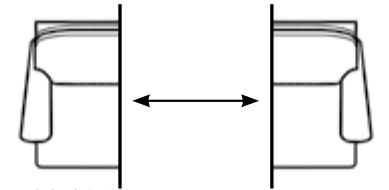

96-9846  
**"By the Inch" Sofa**  
Outside D37 H38  
Inside D20½

Available in any 500 Series arm, back and base style and in any length from 65" to 103"

**OTTOMANS**

Ottomans may be specified with base styles to match your Selectional. Specify the ottoman size below and add the desired base style.



96-9847-2520  
CL-8847-2520  
**Ottoman**  
L25 D20 H19

For example, **96-9847-2520-3HM** Ottoman specifies the **3HM** from the choices on page 51. Finally, select your fabric or leather and then select your finish.



**example:**  
**3HM**  
Medium Leg

96- designates fabric. CL- designates leather. Outside heights vary based on back style (pillow backs are 36½, tightbacks are 36¼). Multiple piece sectionals will be center-matched. Throw pillows are not standard with leather upholstery. All exposed legs are maple. Overall lengths will vary based upon arm selection (see outside dimensions chart on page 46). All component sizes are approximate and will vary slightly based on the thickness of fabric used and the human variables of fine hand craftsmanship. All ottomans have a tight seat design. Ottoman not available with 3W base option. Overall height is determined by back style.

OUTSIDE LENGTHS BASED ON ARM STYLE

500 SERIES

Component #	Description	1A	1E	1G	1S	1T	1Y	1AS	1ES	1GS	1SS	1TS	1YS
96-9831/ CL-8831	Left Facing Loveseat	54½"	54½	54¾	52¾	54½	54½	54½	54½	54¾	52¾	54½	54½
96-9832/ CL-8832	Right Facing Loveseat	54½	54½	54¾	52¾	54½	54½	54½	54½	54¾	52¾	54½	54½
96-9833/ CL-8833	Left Facing Sofa	79¼	79¼	79½	77½	79¼	79¼	79¼	79¼	79½	77½	79¼	79¼
96-9834/ CL-8834	Right Facing Sofa	79¼	79¼	79½	77½	79¼	79¼	79¼	79¼	79½	77½	79¼	79¼
96-9835/ CL-8835	Left Facing Corner Sofa	91	91	91¼	89¼	91	91	91	91	91¼	89¼	91	91
96-9836/ CL-8836	Right Facing Corner Sofa	91	91	91¼	89¼	91	91	91	91	91¼	89¼	91	91
96-9839-2/ CL-8839-2	Two Arm Chaise	34¾	34¾	35¼	35¼	34¾	34¾	34¾	34¾	35¼	35¼	34¾	34¾
96-9839-L/ CL-8839-L	Left Facing Chaise	29¾	29¾	30	28	29¾	29¾	29¾	29¾	30	28	29¾	29¾
96-9839-R/ CL-8839-R	Right Facing Chaise	29¾	29¾	30	28	29¾	29¾	29¾	29¾	30	28	29¾	29¾
96-9840/ CL-8840	One Cushion Left Arm Chair	29¾	29¾	30	28	29¾	29¾	29¾	29¾	30	28	29¾	29¾
96-9841/ CL-8841	One Cushion Right Arm Chair	29¾	29¾	30	28	29¾	29¾	29¾	29¾	30	28	29¾	29¾
96-9842/ CL-8842	One Cushion Arm Chair	32¾	32¾	33½	29½	32¾	32¾	32¾	32¾	33½	29½	32¾	32¾
96-9843/ CL-8843	Two Cushion Loveseat	59½	59½	60¼	56¼	59½	59½	59½	59½	60¼	56¼	59½	59½
96-9844/ CL-8844	Mid-Size Sofa	76¼	76¼	77	73	76¼	76¼	76¼	76¼	77	73	76¼	76¼
96-9845/ CL-8845	Three Cushion Sofa	84¼	84¼	85	81	84¼	84¼	84¼	84¼	85	81	84¼	84¼

SOFAS BY THE INCH

500 SERIES

Creating your own Sofa-by-the-inch is as easy as 1-2-3-4! Start with the Sofa-by-the-inch model number **96-9846 "By the Inch" Sofa**

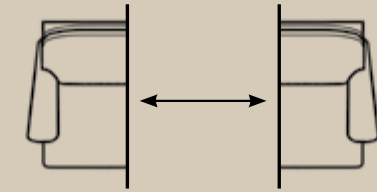

96-9846  
"By the Inch" Sofa  
Outside D37 H38 Inside D20½

Available in any 500 Series arm, back and base style and in any length from 65" to 103"

Now, just follow these **four** simple steps:

- 1** SELECT YOUR ARM STYLE



**example:**  
**1E**  
Welted Sock Arm
  - 2** SELECT YOUR BACK STYLE



**2B**  
Box Back
  - 3** SELECT YOUR BASE STYLE



**3HM**  
Medium Leg
- 4** SELECT YOUR CUSTOM LENGTH

You've selected the **1E** arm style with the **2B** back style and the **3HM** base style. You've also selected your custom length to be **100** inches. So the model number on your order should be **96-9846-1E-2B-3HM-100**

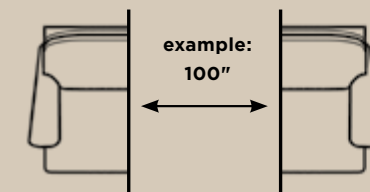

Finally, select your fabric, select your finish and add the frills.

## SOFAS BY THE INCH INSIDE LENGTHS

## 500 SERIES

This chart provides all Sofa-by-the-inch inside length possibilities based on each outside length and arm style. Use the color key below to determine how many seat cushions your sofa will have.

outside length	1A/1AS	1E/1ES	1G/1GS	1S/1SS	1T/1TS	1Y/1YS
65"	55	55	54½	58½	55	55
66	56	56	55½	59½	56	56
67	57	57	56½	60½	57	57
68	58	58	57½	61½	58	58
69	59	59	58½	62½	59	59
70	60	60	59½	63½	60	60
71	61	61	60½	64½	61	61
72	62	62	61½	65½	62	62
73	63	63	62½	66½	63	63
74	64	64	63½	67½	64	64
75	65	65	64½	68½	65	65
76	66	66	65½	69½	66	66
77	67	67	66½	70½	67	67
78	68	68	67½	71½	68	68
79	69	69	68½	72½	69	69
80	70	70	69½	73½	70	70
81	71	71	70½	74½	71	71
82	72	72	71½	75½	72	72
83	73	73	72½	76½	73	73
84	74	74	73½	77½	74	74
85	75	75	74½	78½	75	75
86	76	76	75½	79½	76	76
87	77	77	76½	80½	77	77
88	78	78	77½	81½	78	78
89	79	79	78½	82½	79	79
90	80	80	79½	83½	80	80
91	81	81	80½	84½	81	81
92	82	82	81½	85½	82	82
93	83	83	82½	86½	83	83
94	84	84	83½	87½	84	84
95	85	85	84½	88½	85	85
96	86	86	85½	89½	86	86
97	87	87	86½	90½	87	87
98	88	88	87½	91½	88	88
99	89	89	88½	92½	89	89
100	90	90	89½	93½	90	90
101	91	91	90½	94½	91	91
102	92	92	91½	95½	92	92
103	93	93	92½	96½	93	93

- 2 CUSHIONS
- 3 CUSHIONS
- 4 CUSHIONS

# STICKLEY®

L. & J.G. STICKLEY, INC. • 1 STICKLEY DRIVE, P.O. BOX 480 • MANLIUS, NY 13104-0480  
 T: (315) 682-5500 • F: (315) 682-6306 • WWW.STICKLEY.COM